

ARIAN

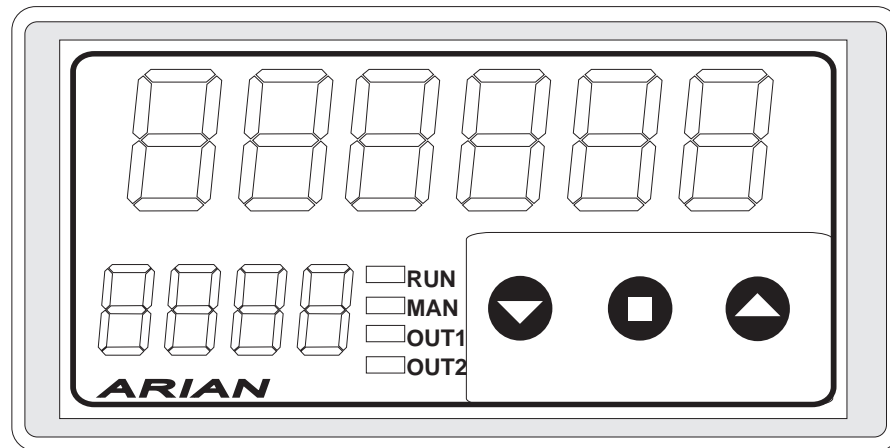

FL20A

Analog Integrating Totalizer Installation and user manual

rev. 07/2009

ARIAN S.A.
El Comendador 2340, Santiago, CHILE
Fono/Fax 4218333
www.arian.cl

PRELIMINARY INFORMATION

This document has copyright reserved, C Arian INC.
Referred trademarks are of property of its respective owners.
ARIAN is registered by Arian S.A.

Technical help

If you find problems with the instrument, check its configuration to be coherent with the application. If still it persists the problem, help can obtain by the following media:

e-mail arian@arian.cl
phone/fax 56-2-4249363
web www.arian.cl

Revision history

rev. 05/05 First release.
rev. 08/2007 Added functionality for totalized count disable.
rev. 07/2009 Cut off function modified on page 14.

GENERAL DESCRIPTION	4
PART CODE	5
TECHNICAL SPECIFICATIONS	6
INSTALLATION	7
Alarm outputs	8
External reset inputs.	8
Analog outputs (optional)	8
RS485 serial communications. (optional)	8
Power supply	8
Panel assembly	8
CONFIGURATION FROM PC (RPS)	9
CONFIGURATION	10
General Configuration menu (O P E r).	11
Input configuration	13
Alarms configuration.	15
Alarm 2 and pulses output.	17
Analog output configuration 4-20 mA. or 0-10V	18
Serial RS485 communications configuration.	20
OPERATION	21
Special reset functions.	21
Access to special functions and registers.	21
Sub-menu r E A d , examine parameter values.	22
Sub-menu F u n c , reset maximum, minimum, disabling outputs.	22
Modify alarms Set Points.	23

GENERAL DESCRIPTION

The FL20A is a analog process variable meters (e.g.. 4-20ma) with integrating capacity. Each second adds the input in a 6 digits counter (Totalized) creating a time integral of the process variable. Typical uses are jointly with analog output flow meters (e.g. magnetic flow meters) allowing to have the flow rate in the lower 4 digit display and the total accumulated flow in the upper 6 digit display.

Inputs

- Standard process variables as 4..20mA, 0..10V,etc.
- Two additional external inputs (dry contact) programmable as reset functions.

Readings

- Totalized in 6 high bright 14.5mm height red digits. (Upper display)
- Input process variable in lower 4 digits.
- Pre-scale, adjust the totalized for any engineering unit.
- Continuous memory, stores last reading.
- Registers maximum and minimum readings for process variable input.

Alarms

- 4 alarms assigned independently to preset values of the totalized count or the input process variable. Are associated to the 2 output relays.
- Latch and standby functions.

Outputs

- Two output relays, with two programmable alarms each (high and low)
- Output pulse with frequency proportional to the analog input. For external totalizing in PLCs.

Communications

- RS485 Modbus RTU serial communications reports data to a PC or PLC.
- Galvanically isolated analog outputs for the process variable. Active loop 4..20ma ,0...10V, passive loop 4..20ma.

Configuration.

- From a PC compatible by means of RPS software.
- From frontal push buttons.

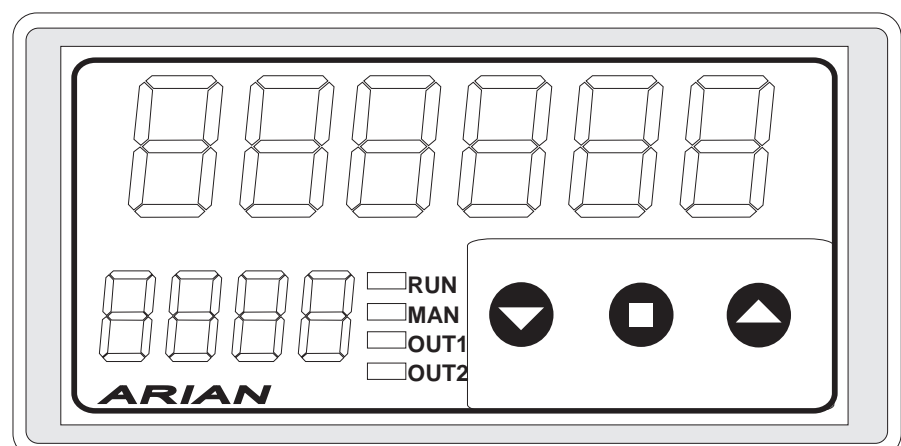

PART CODE

Defining a part number must be done selecting the following options.
Last 2 ones (-420A, -420L), -RS485 are optional that must not be included if no required.

FL20A	-AC -DC	-420A -420L	-RS485
--------------	--------------------	------------------------	---------------

-AC :power supply 85...260 Vac, 6 W, 45...65 Hz.
-DC :power supply 18....60 Vdc, 6 W

OPTIONAL OUTPUT

-420L :4..20ma passive loop

-420A :4..20ma active, includes also 0..10Vdc

OPTIONAL

-RS485 :modbus RTU serial communications

For example:

FL20A-AC

FL20A with, AC power supply , without any optional output.

FL20A-DC-RS485

FL20A with DC power supply and modbus RTU serial communications.

TECHNICAL SPECIFICATIONS

INPUTS	Process variable type: 4...20 mA, 0...20 mA, 0...5 V, 1..5 V, 0..10 V, 0..50 mV
--------	--

DISPLAY	Allows engineering units with decimal places for totalized count and process variable reading. Register max/min of process variable reading. Totalizer: 6 digits Display (14mm), range 0...999999 Analog process variable: 4 digits (9mm), range -999... 9999
---------	---

ALARMS:	2 independent alarm outputs, each one with high and/or low alarm, with absolute or relative set points. Programmable alarm latch and "standby" that inhibits alarms when modifying set points). Can be assigned independently to the process variable or Totalizer.
---------	---

OUTPUTS:	Relays, 2 outputs for alarms 250VAC/ 3A., normally open or normally close by software.
Optional:	-420L 4... 20 mA, loop powered, Vdrop 4.5V max. opto isolated (5kV). -420A 4..20ma/0-10V Active loop, opto isolated (5kV). -RS485 modbus RTU serial communications, opto isolated (5kV).

POWER SUPPLY:	Current mode switching power supply. Versions: 85...260 Vac, 6 W, 45...65 Hz. 20...60 VDC, 6 W, (optional)
---------------	---

CONSTRUCTION:	Aluminum and Polycarbonate; IP65 Total Dimension: DIN 1/8; 96 x 48 x 135 mm. Panel cut: 92 x 45 mm. Weight: 300 grams. Operation temperature: 0 ... 50 °C.
---------------	--

INSTALLATION

Input connections are in terminals #2 and #3 as indicated in the drawing. Terminal 3 is connected to the instrument internal ground and can be used for the connection of external shield of some sensors.

It is important that the cables that bring the sensor signal be apart from cables connected to the output relays since this normally are inductive loaded. When deactivated this relays can generate high voltage spikes that can cross the cable insulator and disturb, even damage the input circuit.

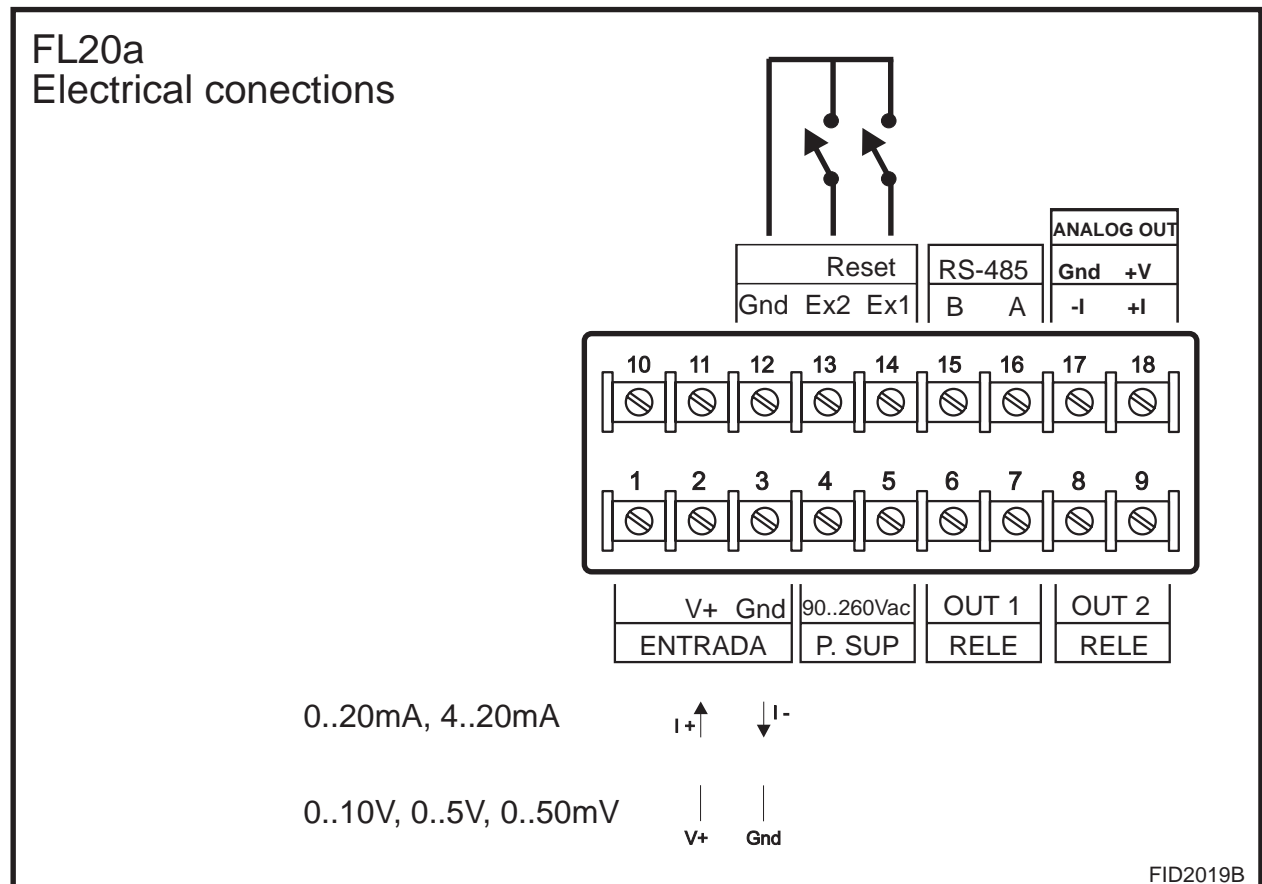

There are internal jumpers to be configured according to the input type that will be used. The input type and ranges must also be specified in the configuration menu.

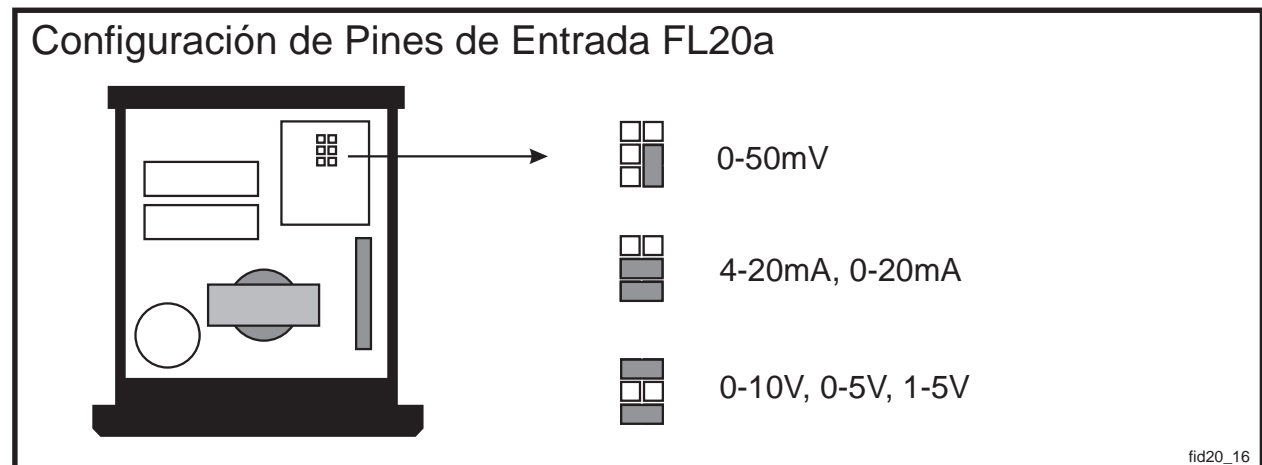

Alarm outputs

Relays are the standard option for alarm outputs. As seen in the figure, relay for alarm 1 (OUT 1) goes to terminals 6 and 7. The one for alarm 2 (OUT 2) to terminals 8 and 9, both are normally open outputs (NO). Care must be taken on not exceeding the maximum relay current (3 Amp.), since they would be damaged quickly. Is recommended to use fuses in series with the relays to protect them. Never use directly the internal relay with the load. Always a external contactor should be used to drive the final load.

External reset inputs.

The instrument haves 2 external inputs for connecting push buttons or switches. In the configuration menu is assigned a function to the inputs, such reset total to cero, reset registered maximum and minimum. Switchs are connected to terminals #14, #13 and #12 (Gnd)

Analog outputs (optional)

For isolating and retransmitting the measured variable to a PLC or another instrument. If this options are installed please refer to "analog output configuration" chapter for details.

RS485 serial communications. (optional)

For communicating with PC or PLC using modbus RTU software protocol. This is an isolated out that drives standard RS485 5Volts signals. If this options are installed please refer to "RS485 communications configuration" chapter for details.

Power supply

The instrument power supply is designed to operate with any voltage between 90 and 260 volts without need of adjustment. (20VDC to 60VDC for the DC power supply option). Once start up will continue operating unless the network fall under 50 VAC. The instrument possesses an internal 0.5Amp fuse that should be replaced with a similar one.

Panel assembly

Designed for panel assembly in a 92 x 45 mm. cut (Format DIN 1/8). using clamps included with the instrument.

CONFIGURATION FROM PC (RPS)

Two displays versions may be programmed by frontal push bottoms while one display versions does not have push bottoms, so only can be programmed from a PC compatible computer. The following is needed:

- The PC compatible computer with vga monitor.
- RPS software (download latest version from www.arian.cl)
- Isolating interface cable. Part# RPS-C

While using the RPS system the configuring menus are the same described in following chapter for frontal push bottoms programming.

With de-energized instrument, the interface cable must be connected by one side to the internal connector as shown in the picture.

The other side of the cable goes to the PC serial RS232 port (DB9). Once done the connection the instrument must be energized and RPS software executed in the PC.

The interface cable does optical isolation between PC and instrument. Concluded the programming you must de-energized the device and then plug off the interface cable.



CONFIGURATION

Operation form must be programed on this configuration menu.

IMPORTANT NOTE:

Once entering on this menu the instrument stops integrating the analog input and will continue only when you exit the menu and return to the operation mode.

To enter the configuration menu press the center button [•] and without releasing it, press and release one time the "right or upper" button [^] . Doing that, the message "KEY" will appear in the upper display. At this moment the instrument asks for a access key. Now the number 2736 should be introduced in the lower display using the "left or lowering" and "right or upper" button. Once the number 2736 is in the lower display, press the button [•] to enter.

Now in the upper display appears the message **M E n u**. With the lateral buttons select one of the 5 menus and to press center button [•] to enter. To quit, select the option "SALi" or wait 16 seconds without pressing any button.

M E n u

O P E r. General menu, configuring displays, operation modes and other options.

I n P t. Analog input configuration.

A L - 1 alarm 1 configuration.

A L - 2 alarm 2 configuration.

4 - 20. analog output, 0...10V, 4...20mA (if it is available)

r 4 8 5 rs485 serial communications.

S A L i Returns to operation mode.

Once entering one of the menus, if no button is press in 16 seconds, the devices returns automatically to operation mode.

At the end of each menu, always is asked if is desired to program the new data and then to quit or continue configuring. These questions are presented as:

P r o g

is asked if is desired to program or not the instrument with the introduced values. Selecting "No", values recently placed will be erased and original values will not change.

N o Do not program new values.

S i Set in EEPROM new values.

S A L i

Select "Si" for quit (exit) the menu and "N o" for returning back to the starting of the actual configuration menu.

N o Continue in this menu.

S i Quit or exit the menu.

General Configuration menu (O P E r).

d i s . b

Refers to the lower display.

o F F Disabled Display.
r A t E Process variable PV (analog input).
M A C S PV maximum.
M i n i PV minimum.

P.d i . b

Places a fixed decimal point in the lower display to facilitate the viewing engineering units.

- - - - Without decimal point.
- - . - -
- . - - -
. - - - -

P.d i . A

Places a fixed decimal point in the 6 digit higher display to facilitate viewing engineering units.
The options are the same described for "display b".

E t r.1

A function is assigned to the external reset input 1, associated to terminal #12.

o F F there is no function assigned.
r S t . N Reset registered maximum and minimum of rate.
r S t . A Reset latched alarms.
d i . A L Disable/restore momentarily the alarm relay outputs.
While disabled the alarms, the "RUN" led on front panel blinks quickly.
r S t . C Reset to zero totalized count.

E t r.2

A function is assigned to the external reset input 2, associated to terminal #13.
Options are the same described for previous case.

b o t . L

Special function set for the Lowering button [v] on the front panel. (the left one).
Options are the same described for previous case.

b o t . H

Special function set for the "high" button [^] on the front panel (the right one).
Options are the same of the previous one.

F u . L c

= No, Si
Special functions lock.
It should be set "Si", to restrict operator access to "F u n c" special

functions menu (e.g.. reset maximum, minimum, alarms, etc.) as described in operation chapter.

P r o g

= No, Si

Set "Si" for programming new data. Otherwise data will be lost when quitting this menu.

S A L i

= No, Si

Set "Si" for quitting this menu. Otherwise return back to its starting point.

Input configuration

Previously must be set the input configuring pins (for current or voltage input) as described in the installation chapter.

t Y P E

Processes input type.

	Type	Range
<u>0 - 20.</u>	0- 20 milliamperes.	-24 , 24 mA.
<u>4 - 20.</u>	4- 20 milliamperes.	2 mA, 24 mA.
<u>0 - 5 v.</u>	0- 5 volts.	-2 V, +12 V
<u>1 - 5 v.</u>	1- 5 volts.	-2 V, +12 V
<u>0 - 10.</u>	0- 10 volts.	-2 V, +12 V
<u>0 - 50</u>	0- 50 millivolts.	-10 mV, +60 mV

L. i n F

= -999... 9999

Introduce reading value for input at the lower limit of selected input type. For example the input is 4-20mA and comes from a flow sensor that gives 4 mA at 0 kg/hour flow and 20 mA at 1000 kg/hour. In this case is being asked for the reading at 4 mA, that is LinF = 0.

L. S u P

= -999... 9999

Introduce reading value for input at the higher limit for selected input type. For the same previous example, it is asking for reading at 20mA input, that is LSuP = 1000.

F I L t

= 1 ... 16

Corresponds to a time constant for filtering or conditioning noisy inputs. Internally the instrument carries out a first order low pass filter calculation with time constant "FILt". Can be set between 1 and 16 seconds. Better you should leave this value set to 1 second, increasing it only if its required by having noisy readings.

Accumulator

The totalized flow is actualized adding each second the process variable to the last totalized.

The reading is presented in the higher 6 digits display and is obtained by dividing the internal totalized value by a constant. This constant allows to adjust for engineering units.

For example the input is 12ma, that in scaled 4-20 as 0-1000kg/hour, gives a process variable of 500kg/hour.

If the input is stable, each second 500 is added to the internal totalized. If the input is constant one hour, then 500 had been added 3600 times. So the totalized had increased 1800000.

If you want to have the totalized reading in kg, you must divide by 3600.

This way if you reset the instrument and let it work 1 hour with the constant 12ma input, the reading will be 500.

$$(500\text{kg/hour} \times 3600) / [3600] = 500$$

In order to have the reading in kg with one decimal point (e.g. 100.3kg), then you must divide by 360 (so reading would be 5000 in stead of 500) and also activate the decimal point as indicated in the general configuration menu.

The division constant may have any value in the range of 0...999999 and is entered in 2 parts, first the 4 less significant digits and then the 2 most significant in order to have a 6 digit number.

<u>k.cn. 4</u>	= 0... 9999	4 less significant digits
-----------------------	-------------	---------------------------

<u>k.cn. 2</u>	= 0... 99	the 2 most significant.
-----------------------	-----------	-------------------------

<u>t. Inh</u>	= Off, On	Totalized count inhibition enable. If enabled, each second the input is compared with the number set as <u>r.Lin</u> if lower then the totalized count update is not done.
----------------------	-----------	---

<u>r. oFF</u>	= Off, On	Rate cut-off enable. If enabled, the input is compared with the number set as parameter <u>r.Lin</u> if lower then the input rate is set to zero. This is a cut-off level for the input. Use it for example if you don't want to have input negative values (set <u>r.Lin</u> =0).
----------------------	-----------	--

<u>r. Lin</u>	= 0... 9999	Rate lower limit. Input lower limit used when enabled some of the 2 preceding options.
----------------------	-------------	---

<u>P r o g</u>	= No, Si	Set "Si" for programming new data. Otherwise data will be lost when quitting this menu.
-----------------------	----------	---

<u>S A L i</u>	= No, Si	Set "Si" for quitting this menu. Otherwise return back to its starting point.
-----------------------	----------	---

Alarms configuration.

The FL20A possesses 2 independent alarms (alarm-1 and alarm-2) each one associated to a output relay (relay-1 and relay-2)

This alarms can be associated to the rate or to the totalized count readings independently.

Each one of the alarms (alarm-1 and alarm-2) has 2 Set Points, high and low. The alarm will activate when the input passes one of these limit.

Once the alarm condition is set, the upper display will operate intermittently indicating that this condition exists.

Both Set Points (high and low) for each alarm possess programmable hysteresis and can be defined as absolute value or relative (displacement) to a common Set Point.

Now is described the configuration for alarm-1.
Configuration of alarm-2 is similar.

A L A r

Selects the variable associated with alarm 1.

r A t E rate

C n t r totalized count

Depending on the selected option the alarm operation form varies.

Selecting C n t r disables Latch and Standby functions. Also will be not available the d o n F option for high and low alarms.

When r A t E is selected, then the following parameters are required.

H i g h

High set point for alarm-1.

o F F Disabled.

o n F h On/off with hysteresis high alarm. The alarm activates when input is **higher** than a value programmed in the parameters menu.

d o n F Dual on/off type high alarm. The alarm activates when input is **higher** than a value defined by general Set Point "SP. rE" **plus** a displacement programmed in the parameters menu.

L o w

Low set point for alarm-1.

o F F Disabled.

o n F h On/off with hysteresis high alarm. The alarm activates when input is **lower** than a value programmed in the parameters menu.

d o n F Dual on/off type high alarm. The alarm activates when input

is **lower** than a value defined by general Set Point "SP. rE" **minus** a displacement programmed in the parameters menu.

L t c h

Enable Latch alarm.

If enabled, the alarm condition output will be maintained although the condition that generated it disappears.

Operator must reset the latched alarm from the front panel.

No disable

Si. enable

S t b Y

The "standby" function inhibits alarm activation when the operator changes the Set Point or the instrument is powered up.

If alarm condition is given in that situation, the activation of the alarm-1 is inhibited until the condition that generates the alarm disappears.

After the condition that generates the alarm disappears (e.g.. the rate reading arrived to the new set point) then the alarm is ready to be activated by normal operation.

No disable

Si. enable

r E L E

Is specified if the relay-1 will work normally open or normally closed. This relay is active when alarm-1 condition exists.

d i r Relay works direct , normally open.

i n v Works inverted or normally closed.

P r o g

= No, Si

Set "Si" for programming new data. Otherwise data will be lost when quitting this menu.

S A L i

= No, Si

Set "Si" for quitting this menu. Otherwise return back to its starting point.

Alarm 2 and pulses output.

Alarm 2 is configured in identical way that is done for alarm 1, but the output is related to relay 2.

The only difference is an additional option for emitting pulses with the relay for external counting. Pulses rate are proportional to the analog input. This way pulses can be count in a PLC.

Once entering Alarm-2 configuration menu the following is requested.

A L A r

Selects operation form of the alarm a relay.

r A t E alarm set to the process variable input.

C n t r alarm set to the totalized count.

P u L S Pulse output on relay-2

Depending on the selected option the alarm operation form varies.

Selecting r A t E or C n t r makes this alarm to operate the same way as described for alarm-1. If P u L S is selected the output pulses on relay-2 are enabled and the following is requested.

P.C t E

= 1... 9999

Division constant for output pulses.

Each second it is evaluated how much the totalized is increased. A pulse will be emitted for increase equivalent to the division constant. The pulses will be emitted by relay-2 in the following second.

For example if the input rate is 500kg/hour y and the totalizer prescale is 3600, then the totalized will be in kg, each unit the totalized increases is equivalent to 1kg.

If you need that the instrument send 1 pulse for each 100kg increase, then set the output prescale P.C t E = 100. Same way if you need 1 pulse for each kg, set P.C t E = 1.

The maximum number of pulses that can be emitted by second is 100, but if the output relay is mechanical type (there is the option for SSR Relay) no more than 4 pulse by second should be allowed because of speed response limitation of the relay. For this reason the maximum expected input rates must be considered when you set the constant.

Emitted pulses are always 50% duty cycle. If one pulse/second is emitted the relay will be 0.5 seconds active and 0.5 second deactivated. If 4 pulse seconds are emitted relay will be 0.125s active and 0.125 deactivated.

Analog output configuration 4-20 mA. or 0-10V

This output is optional although the configuration menu is in all instruments, hardware (the optional output board) could not be installed. There are 2 analog output types, both optically isolated.

Option -420LP, is 4-20ma loop Powered that requires a voltage source in series with the loop. Its typical use is conditioning and isolating process variable for other instruments as e.g.. PLC or DCS.

Option -420AC, is 0-20mA, 4-20mA or 0-10V, active output. Its used to send the selected variable to instruments whose input should be active (powered) such as 0-10v or a 4-20ma loop powered valve.

Exists an internal jumper that must be placed depending on current or voltage output (see figure in the following page)

The questions in the menu vary slightly according to board type installed.

Option -420LP

4 - 20

o F F
o n

Disable output.
enabled.

Option -420AC

t Y P E

o F F
0 - 2 0
4 - 2 0
0 - 1 0

Disabled.
0 to 20 mA.
4 to 20 mA.
0 to 10 Volts.

V A r b

Asks by the variable that will be transmitted. See in the following page the table for the possible analog output variables.

E. i n F

= -999... 9999

Introduce the value of the selected output variable for which the output will deliver 4 mA. (or 0 Volts). For example if output for input temperature was selected, when "E. i n F" = 0, the output will be 4 mA for zero degrees temperature. For lower temperatures the output will descended down to 3.5 mA. aprox.

E. S u P

= -999... 9999

Introduce the value of selected output variable for which the output will deliver 20 mA. (or 10volts). For the same example, place "E. S u P" = 1000, then the output will be 20 mA when temperature is 1000. For higher temperatures the output will rise up to 20.5mA.

C A L i

This refers to output board calibration, is reserved for manufacturer use.

P r o g

= No, Si

Set "Si" for programming new data. Otherwise data will be lost when quitting this menu.

S A L i

= No, Si

Set "Si" for quitting this menu. Otherwise return back to its starting point.

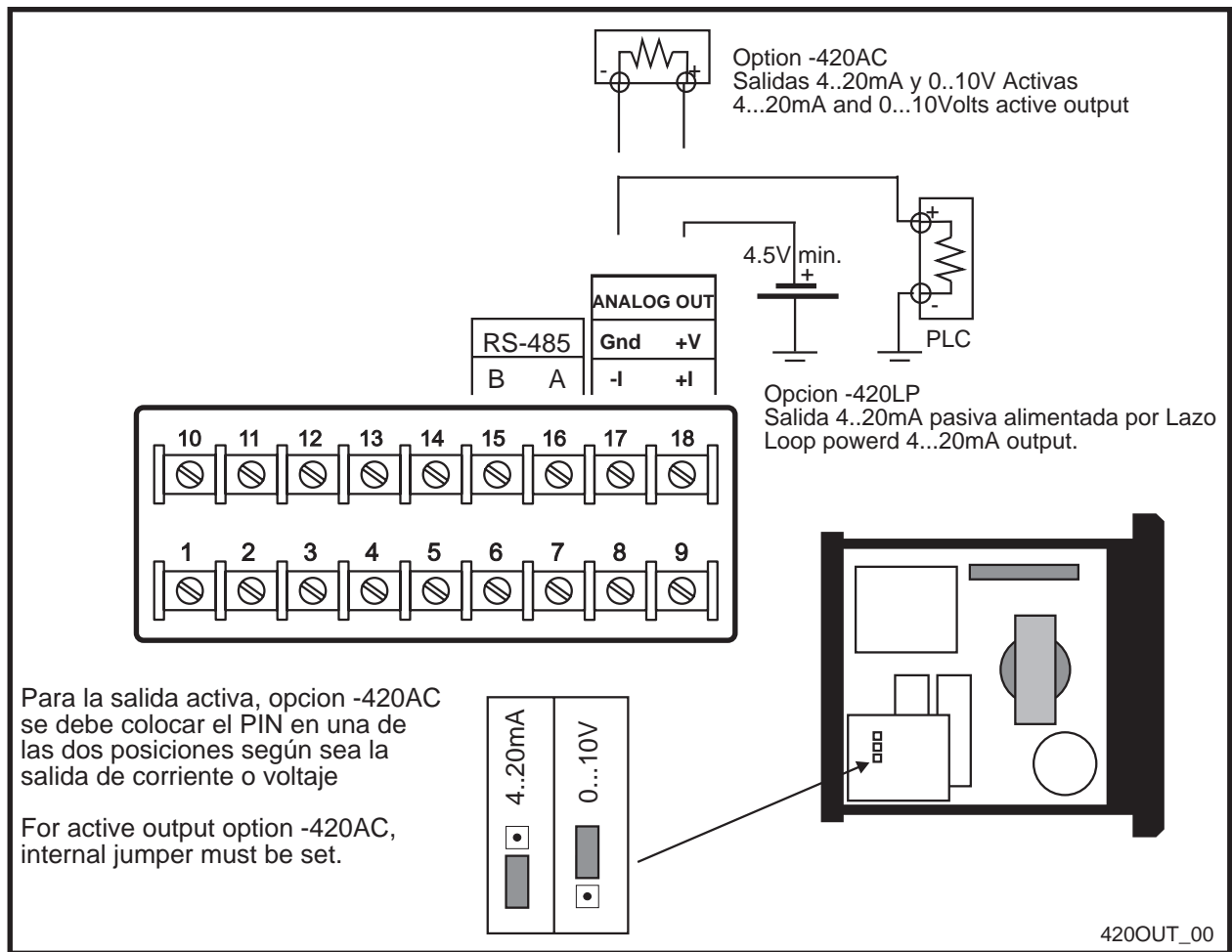

Possible analog output variables for the FL20A

<u>I n P t</u>	Process variable (input).
<u>d E S</u>	Desviation, output proporcional to (<u>I n P t</u> - <u>S P. r E</u>).
<u>S P. r E</u>	Relative Set Point. (use on alarms)
<u>M A C S</u>	Process variable maximum.
<u>M i n i</u>	Process variable minimum.

Serial RS485 communications configuration.

Serial rs485 communications are optional, although the configuration menu is in all the instruments, hardware for its operation could not be installed. The command description for the communications protocol is available as file in internet (www.arian.cl) and includes tag listing with its properties and scales.

Characteristics : - RS485 physical protocol with optically isolated interface.
- start bit, 8 data bits, parity bit = 0, stop bit
- communication protocol, Modbus RTU ,functions 03, 06, 10

The questions in the configuration menu are the following.

n o d E o F F, o N
Enable or disable communications.

b A u d 300, 600, 1200, 2400, 3600, 4800, 9600, 19.2k
Communication speed.

n. S c L = 1...247
Slave number.

P r o g = No, Si
Set "Si" for programming new data. Otherwise data will be lost when quitting this menu.

S A L i = No, Si
Set "Si" for quitting this menu. Otherwise return back to its starting point.

OPERATION

The location of the front panel buttons can be seen in the figure. The central button [•] is the main one, is used for selecting and entering parameters. Lateral buttons are used to increase or decrease selected parameter.

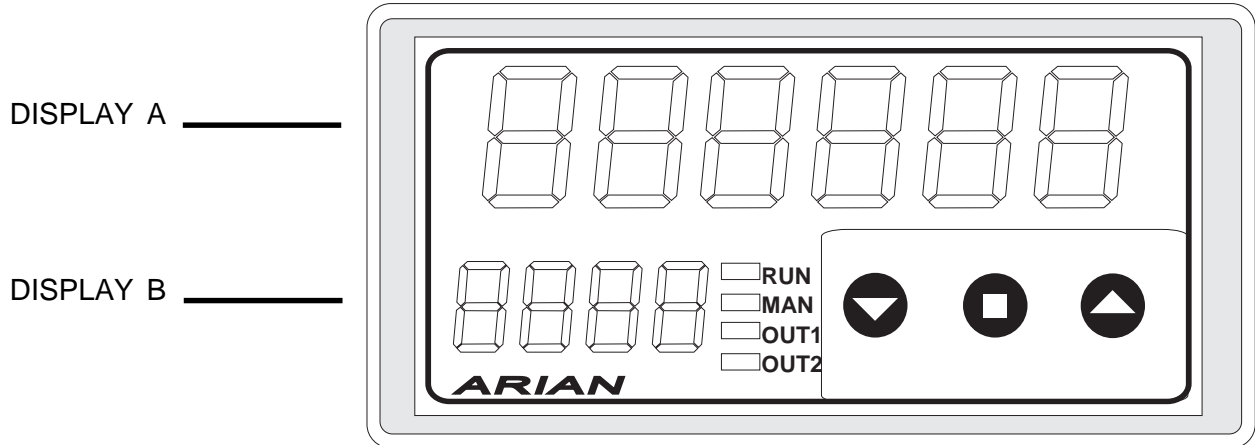

Activated alarm

Leds "OUT 1" and " OUT 2" reflect alarm relays state (activated or deactivated) . Once an alarm (AL- or AL-2) is activated, the lower display reading starts blinking (1 time/2 seconds) for advising the operator that a alarm condition has occurred.

Special reset functions.

If these functions are enabled from the general configuration menu, is possible to reset the maximums, minimum, latched alarms or disable momentarily the relay outputs by pressing one of the front panel buttons [^] or [v].

Access to special functions and registers.

For entering to the menu press the center button [•], immediately one of 2 submenus should be selected by means of the lateral buttons and finally press again the center button [•] to enter the selected sub-menu.

r E A d Examine parameters values.

F u n c Reset functions and outputs disable.

While you are within this menus, the instruments continues integrating the analog input.

Following the content of each sub-menu is described.

Sub-menu rEAd , examine parameter values.

This menu only permits to examine (not to modify) the values of some internal parameters.

With lateral buttons you can scan parameters. Pressing central buttons returns to normal operation mode.

<u>r A t E</u>	process variable reading PV.
<u>M A C S</u>	Maximum registered for PV.
<u>M i n i</u>	Minimum registered for PV.
<u>S P. r E</u>	Shows general Set Point for alarms configured with relative set points.

Sub-menu F u n c , reset maximum, minimum, disabling outputs.

This menu can be locked from the configuration menu, in that case the upper display shows the message L o c k.

Once entering this Sub-menu can be selected one of the following special functions that will be executed immediately.

<u>r S t . N</u>	Resets registered maximum and minimum of PV.
<u>r S t . A</u>	Resets latched alarms.
<u>d i . A L</u>	Disables momentarily and enables the relay outputs. If outputs are momentarily disabled by this function, the RUN led in front panel blinks rapidly.
<u>r S t . C</u>	Resets (returns to cero) the totalized count.

Once a function is selected with the lateral buttons press central button [•], and will be executed in the instantaneously and instrument returns back to normal operation mode.

If no button is press in 16 seconds, the instruments exits menu.

Modify alarms Set Points.

IMPORTANT NOTE

Once entering this menu the instrument stops integrating the process variable and will start doing it again when you exit the menu.

To enter the menu press the center button [•] and without releasing it, press and release one time the "right or upper" button [^] . Doing that, the message "KEY" will appear in the upper display. At this moment the instrument asks for a access key. Now the number 1234 should be introduced in the lower display and then pressed the button [•] to enter.

The FL20A possesses 2 independent alarms (AL-1 and AL-2) each one associated to a output relay and can be linked to totalized count or PV. Each alarm possesses a high and low set points.

When the measured variable is lower to the low set point or higher to high set point, the alarm and its corresponding relay is activated.

For example the alarm-1, low has a set point SP.1L that can be obtained in two different ways depending if it was configured as absolute (onFh) or relative (donF) in the alarm configuration menu.

$$\begin{aligned} \text{SP.1L} &= \text{S P. r E} - \text{1. L. d S} && \text{case } \text{donF} \\ \text{SP.1L} &= \text{1. L. S P} && \text{case } \text{onFh} \end{aligned}$$

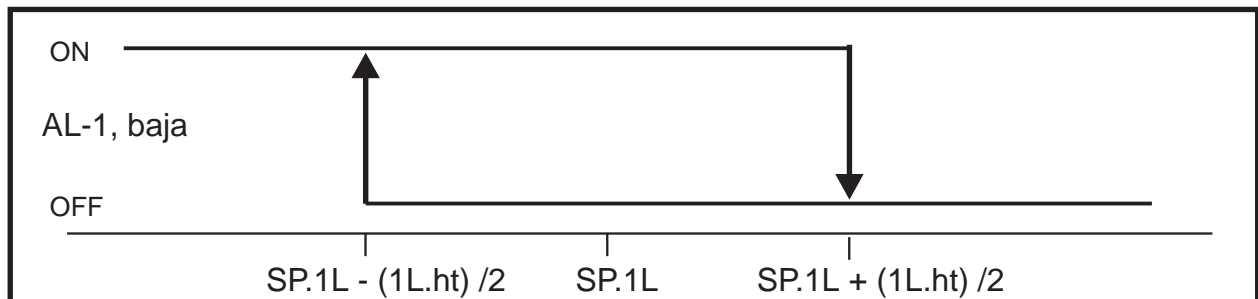

In the same way for high alarm-1 :

$$\begin{aligned} \text{SP.1H} &= \text{S P. r E} + \text{1. H. d S} && \text{case } \text{donF} \\ \text{SP.1H} &= \text{1. H. S P} && \text{case } \text{onFh} \end{aligned}$$

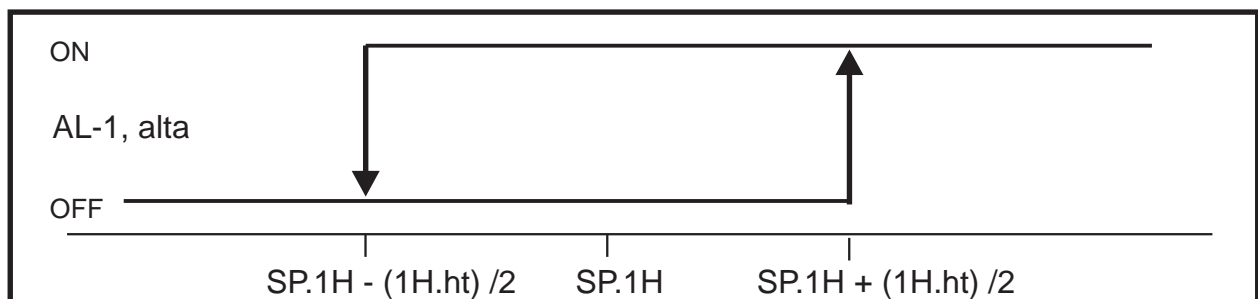

This menu is different depending if you have chosen to associate the alarm to totalized count or PV also depends on the enabled options in the configuration menu.

Alarm-1, associated to process variable.

If alarm AL-1 or AL-2 or both are enabled as relative alarms, the is required to set:

S P. r E = -999,... 9999
General Set Point used in calculation of alarm operation point, only for alarms configured as relative (d o n F) .
This parameter is asked only if some alarm was set as d o n F , other case is omitted.

Alarm-1, High

According on value H i g h for AL-1 configuration, the following cases will be given :

Case o F F Nothing is asked, high alarm is disabled.

Case onFh

1. H . SP = -999,... 9999
Set Point for AL-1 high. Becomes active when:
 $PV > \underline{1. H . SP}$ Considering hysteresis.

1. H . ht = 0... 999
Hysteresis for the activation and deactivation of the AL-1 high.

Case donF

1. H . dS = -999,... 9999
Alarm-1 high activation point separation referred to **S P. r E** .
Will become active when:
 $PV > \underline{S P. r E} + \underline{1. H . d S}$ Considering hysteresis.

1. H . ht = 0... 999
Hysteresis for the activation and deactivation of the AL-1 high.

Alarm-1, Low

According on value L o w for AL-1 configuration, the following cases will be given :

Case o F F Nothing is asked, low alarm is disabled.

Case onFh

1. L . SP = -999,... 9999
Set Point for AL-1 low. Becomes active when:
 $PV < \underline{1. L . SP}$ Considering hysteresis.

1. L . ht = 0... 999
Hysteresis for the activation and desactivation of the AL-1 low.

Case donF

1. L . dS = -999,... 9999

Alarm-1 low activation point separation referred to **S P. r E** .

Will become active when:

PV < S P. r E - 1. L . d S Considering hysteresis.

1. L . ht = 0... 999

Hysteresis for the activation and deactivation of the AL-1 low.

Alarm-2, Rate associated.

Alarm-2, High

Depending on value of H i g h for AL-2 configuration, the following cases will be given:

Case o F F Nothing is asked, high alarm is disabled.

Case onFh

2. H . SP = -999,... 9999
Set Point for AL-2 high. Becomes active when:
 $PV > \underline{2. H . SP}$ Considering hysteresis.

2. H . ht = 0... 999
Hysteresis for the activation and deactivation of the AL-2 high.

Case donF

2. H . dS = -999,... 9999
Alarm-2 high activation point separation referred to **S P. r E** .
Will become active when:
 $PV > \underline{S P. r E} + \underline{2. H . d S}$ Considering hysteresis.

2. H . ht = 0... 999
Hysteresis for the activation and deactivation of the AL-2 high.

Alarm-2, Low

Depending on value of L o w for AL-2 configuration, the following cases will be given:

Case o F F Nothing is asked, low alarm is disabled.

Case onFh

2. L . SP = -999,... 9999
Set Point for AL-2 low. Becomes active when:
 $PV < \underline{2. L . SP}$ Considering hysteresis.

2. L . ht = 0... 999
Hysteresis for the activation and deactivation of the AL-2 low.

Case donF

2. L . dS = -999,... 9999
Alarm-2 low activation point separation referred to **S P. r E** .
Will become active when:
 $PV < \underline{S P. r E} - \underline{2. L . d S}$ Considering hysteresis.

2. L . ht = 0... 999
Hysteresis for the activation and deactivation of the AL-2 low.

Alarm-1 associated to totalized count.

Alarm-1, High

Depending on value of H i g h for AL-1 configuration, the following cases will be given:

Case o F F Nothing is asked, high alarm is disabled.

Case onFh

Set Point for AL-1 high is active when:
Totalized > SP

Set point is entered in 2 parts, first the 4 less significant digits and then the 2 most significant in order to have a 6 digit number for SP.

1.H.S.4 = 0,... 9999

1.H.S.4 = 0,... 99

Alarm-1, Low

Depending on value of L o w for AL-1 configuration, the following cases will be given:

Case o F F Nothing is asked, low alarm is disabled.

Case onFh

Set Point for AL-1 high is active when:
Totalized < SP

Set point is entered in 2 parts, first the 4 less significant digits and then the 2 most significant in order to have a 6 digit number for SP.

1.L.S.4 = 0,... 9999

1.L.S.4 = 0,... 99

Alarm-2 associated to totalized count.

Is configured in the same way as explained for Alarm-1, high and low.